

Article number: 203502702250ST

Description: E+G Levelling sets GN 350.2-70-22-50-ST

Measures

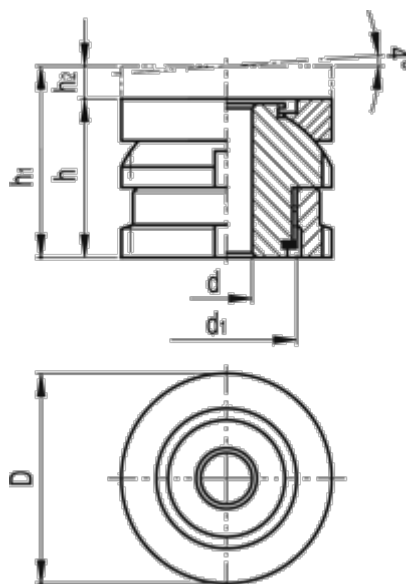

C-spanner DIN 1810 = A68-75

d = 22

D = 70

d1 = M50x1.5

For screw = M20

h = 50

h1 = 60

h2 = 10

Max static load (kN) = 225

Static preload (kN) = 136.08

Weight (g) = 1300